

Use and maintenance manual for vibrating fork level indicator series GVS25

PRODUCT IDENTIFICATION

The GVS25 series are vibrating fork level indicators for powders and granules, up to 10mm in size. Larger materials may get stuck eventually in the fork and thus give false signals. The unit is identified by the label on the side of the housing, as shown below:

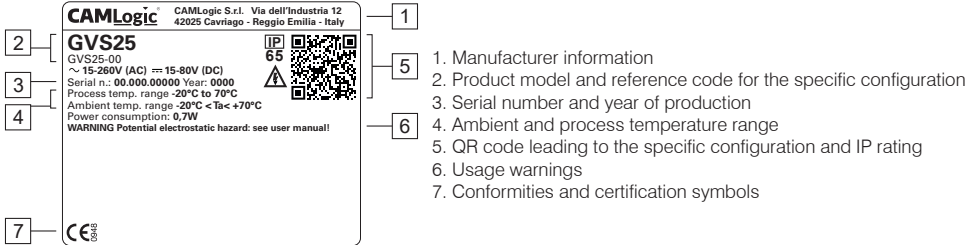

Tampering with the label entails the loss of validity of the certifications and the warranty.

PRODUCT CHARACTERISTICS

- Casing and cover in die-cast aluminium
- G 1" 1/2 (BSPP) connection to process and vibrating fork in AISI 316L / EN 1.4404 stainless steel
- Cable entry M20x1,5 or 1/2 NPT (on request)
- Power supply voltages: 15-260V (AC) - 50...60Hz (AC) or 15-80V (DC)
- Power consumption: max 0,7W
- Cables size: 0,5 ÷ 2,5 mm² (14 AWG)
- Contacts capacity: 5A at 220V (AC) or 24V (DC)
- Signal output: DPDT
- Ambient temperature: -20 ÷ +70°C (-4 ÷ 158°F)
- Process temperature: -20 ÷ +70°C (-4 ÷ 158°F)
- Process pressure: -20 ÷ +200°C (-4 ÷ 392°F) for GVS25AT models
- Sensitivity: 0,8 ÷ 15 bar (11,6 ÷ 218 psi)
- Casing protection rating: material size max 10mm / minimum density 0,2 Kg/dm³
- Wetted parts protection rating: IP65 (dust-tight, protection against water jets)
- Wetted parts protection rating: IP68 (dust-tight, protected against the effect of continuous immersion in water)

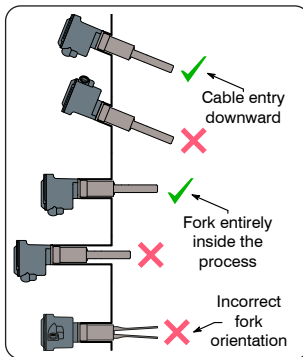

INSTALLATION

The indicator can be mounted in any position, on the wall of the silo or container, taking care to keep the cable entry pointing downward.

In the case of installation on the side, the prongs of the fork should be positioned vertically (as shown in the picture alongside).

If the indicator is also installed in close proximity to the material inlet, the fork should be protected from falling material with a canopy or baffle of suitable strength.

The coupling of the instrument with the silo or container wall can be threaded or flanged; the reference figures on page 3 show the general dimensions and standard product couplings. Always refer to the technical drawings provided by the manufacturer along with the manual.

Seal the cable entry with cable glands suitable for the working range indicated on the label. The red protective cap supplied with the device serves only to protect it during transport; it is not suitable for use during operation of the instrument and is the responsibility of the installer to replace it.

The diameter of the power cable must match the clamping range indicated by the cable gland used.

SAFETY WARNINGS

Installation, maintenance, and diagnostics of the device should be carried out only by authorized personnel who are informed of current regulations. Before starting work, trained personnel must have read and understood the instructions. When using electrically operated equipment, appropriate safety precautions, as required by current regulations, must be taken to reduce the risk of fire, electric shock and injury to persons.

Before installing the device, check its perfect integrity by ensuring that it has not been damaged during transportation.

Removal/replacement/modification of any part of the device, will result in the loss of validity of the prodotti themselves. Grounding is mandatory and the sole responsibility of the installer.

WIRING

The electrical connection of the device must be made while the device is not powered.

The earthing, in particular, must be made before any other, using an M5x8 screw and a notched stainless steel washer.

There are two protective earth connection terminals on the device, one inside the enclosure (terminal 3) and one outside near the cable entry, marked IEC 60417-5019.

The cross section of the protective earth (PE) conductor should be the same as that of the phase conductor, with a maximum of 2.5 mm².

Protect the cables with an overload protection element (rated current ≤ 2A).

A disconnect switch must be present near the device so that the power supply can be cut off in case of a fault. The picture shows the wiring diagram, also printed on the mask covering the electronic components, inside the instrument.

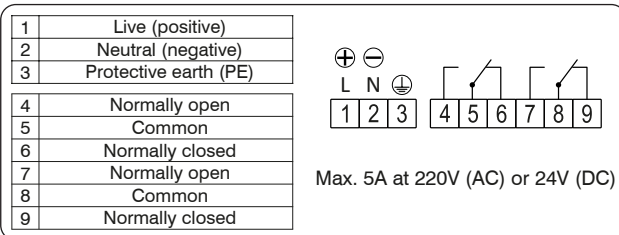

CONFIGURATION

Configuration of the product is done using the switches inside, which as a standard are set to OFF.

The picture shows the switches, each of which has an identifying number, as well as an example of the OFF and ON positions.

Each individual switch corresponds to a specific function described below:

1. Failsafe setting

For the instrument to operate safely, this switch must be set according to the installation and use of the indicator. If installed to check the maximum level, leave the selector switch to **OFF**.

Conversely, for minimum level control, the selector should be set to **ON**. In case of failure or malfunction, it is designed to return to the safest condition, as evidenced by the summary tables below and on the next page.

2. "WET" delay of 5 seconds

Setting the switch to **ON** allows you to set a 5-second delay in the signal, when the fork is covered by the material. No delay, however, with the switch set to **OFF**.

3. "DRY" delay of 5 seconds







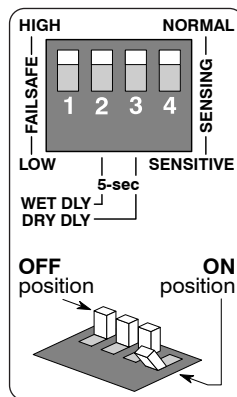

Setting the switch to **ON** allows you to set a 5-second delay in the signal, when the fork returns free from the material. No delay, however, with the switch set to **OFF**.

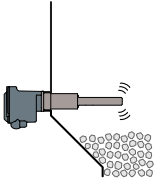
4. Sensitivity control

With the selector switch set to **OFF**, the instrument can detect materials with a minimum density of 0.4 kg/dm³. For lighter materials, up to 0.2 Kg/dm³, move the selector switch to **ON**.

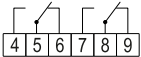
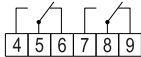
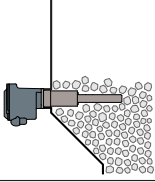

	Material status / LED status	Failsafe	Contacts (power on)	Contacts (power off)
Maximum level (HIGH)	 ABSENCE OF MATERIAL ALARM (grey) NORMAL (green) STATUS	 Switch #1 OFF FAILSAFE HIGH	 Relay energized Normal operation	 Relay not energized No power supply
	 PRESENCE OF MATERIAL ALARM (red) NORMAL (grey) STATUS	 Switch #1 OFF FAILSAFE HIGH	 Relay not energized Alarm	 Relay not energized No power supply

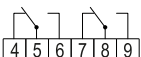
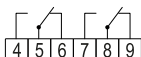
	Material status / LED status	Failsafe	Contacts (power on)	Contacts (power off)
Minimum level (LOW)	 <p>ABSENCE OF MATERIALE</p> <p>ALARM  NORMAL </p> <p>STATUS</p>	 <p>Switch #1 ON FAILSAFE LOW</p>	 <p>Relay not energized</p> <p>Alarm</p>	 <p>Relay not energized</p> <p>No power supply</p>
	 <p>PRESENCE OF MATERIAL</p> <p>ALARM  NORMAL </p> <p>STATUS</p>	 <p>Switch #1 ON FAILSAFE LOW</p>	 <p>Relay energized</p> <p>Normal operation</p>	 <p>Relay not energized</p> <p>No power supply</p>

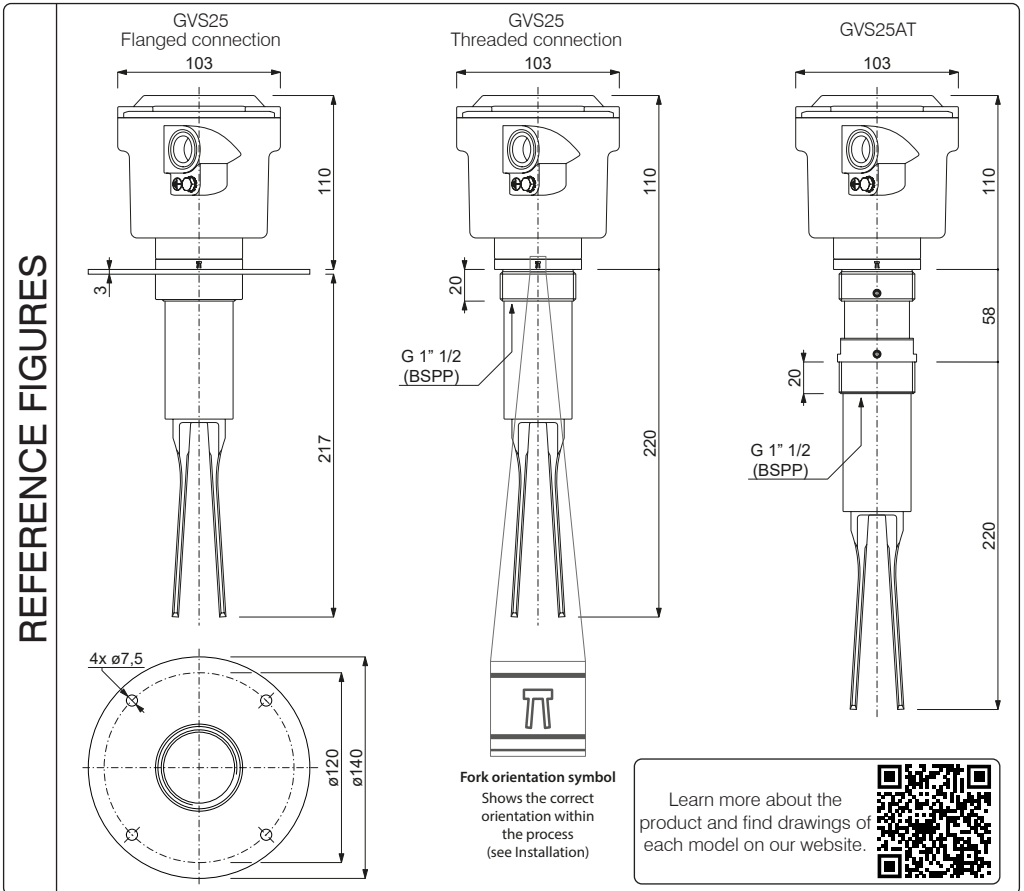

MAINTENANCE

CAMLogic instruments do not require routine maintenance, however the following check is recommended each time the cover is opened or the instrument is removed: visually check the seals present.

Always turn off the power before opening the instrument cover.

If there are signs of damage or excessive tearing of the lid gaskets or other parts of the device, contact the CAMLogic manufacturer for replacement with suitable materials. Cover screws should be fully tightened and cable glands and/or end caps should be tightened securely; ensure that power and ground terminals are connected properly and in good condition.

REPAIRS

GVS25 series level indicators can only be repaired by the CAMLogic manufacturer or by following the manufacturer's instructions. If in doubt about malfunctions or repairs, contact the manufacturer: CAMLogic S.r.l. - Via dell'Industria 12-12/A - 42025 Cavriago (RE) - Italy (camlogic@camlogic.it - www.camlogic.it).

WARRANTY

CAMLogic, in addition to the terms of the supply contract, guarantees its products for a period of twenty-four (24) months from the date of shipment. This warranty shall be expressed exclusively in the repair or replacement free of charge of parts which, after careful examination by the manufacturer, are found to be defective.

The warranty, excluding any liability for direct or indirect damages, shall be limited to material defects only and shall have no effect if the returned parts are found to have been in any way disassembled, tampered with or repaired by anyone other than the manufacturer.

Also excluded from the warranty is damage resulting from negligence, carelessness, incorrect or improper use of the level indicator, or mishandling by the operator and improper installation. The warranty is also void if non-original spare parts have been used. A returned level indicator, even if under warranty, must be shipped freight prepaid.